

Codice Dianflex: 110-1928

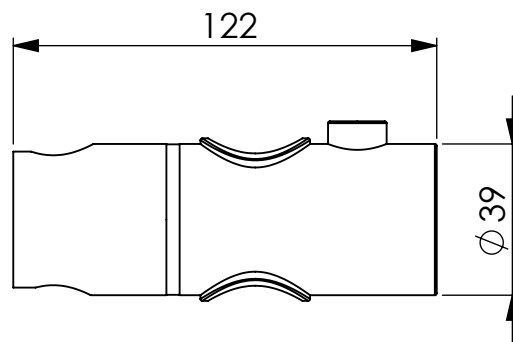
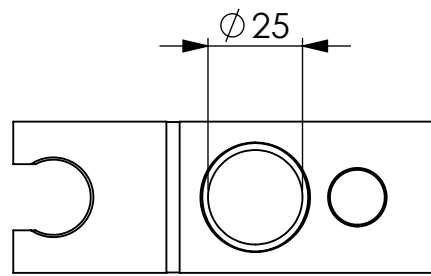

Rev. Dianflex: 06/2025

SE NON SPECIFICATO: QUOTE IN MILLIMETRI	FINITURA: Cromo	COD. ARTICOLO 12133
TOLLERANZE: LINEARE: ANGOLARE:		

	NOME	FIRMA	DATA
DISEGNATO	RP		14.05.2021
VERIFICATO			
APPROVATO			
REVISIONE			



	MATERIALE: ABS
	PESO:

DESCRIZIONE Scorrevole SC 110	A4
SCALA 1:2	FOGLIO 1 DI 1